

Operator's manual
K 3000 Cut-n-Break

Please read the operator's manual carefully and make sure you understand the instructions before using the machine.

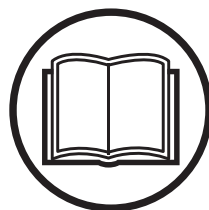

English

KEY TO SYMBOLS

Symbols on the machine:

WARNING! The machine can be a dangerous tool if used incorrectly or carelessly, which can cause serious or fatal injury to the operator or others.

Please read the operator's manual carefully and make sure you understand the instructions before using the machine.

Always wear:

- Approved protective helmet
- Approved hearing protection
- Protective goggles or a visor

This product is in accordance with applicable EC directives.

WARNING! Dust forms when cutting, which can cause injuries if inhaled. Use an approved breathing mask. Always provide for good ventilation.

WARNING! Sparks from the cutting blade can cause fire in combustible materials such as: petrol (gas), wood, dry grass etc.

Water cooling must always be used.

WARNING! Kickbacks can be sudden, rapid and violent and can cause life threatening injuries. Read and understand the instructions in the manual before using the machine.

Always cut in the correct direction. See safety instructions!

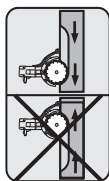

Environmental marking. Symbols on the product or its packaging indicate that this product cannot be handled as domestic waste. It must instead be submitted to an appropriate recycling station for the recovery of electrical and electronic equipment.



By ensuring that this product is taken care of correctly, you can help to counteract the potential negative impact on the environment and people that can otherwise result through the incorrect waste management of this product.

For more detailed information about recycling this product, contact your municipality, your domestic waste service or the shop from where you purchased the product.

Other symbols/decals on the machine refer to special certification requirements for certain markets.

Symbols in the operator's manual:

Inspection and/or maintenance should be carried out with the motor switched off and the plug disconnected.

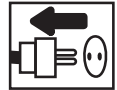

Always wear approved protective gloves.

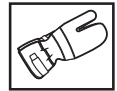

Regular cleaning is required.

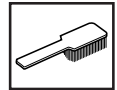

Visual check.



Protective goggles or a visor must be worn.



CONTENTS

Contents

KEY TO SYMBOLS

Symbols on the machine: 2

Symbols in the operator's manual: 2

CONTENTS

Contents 3

WHAT IS WHAT?

What is what on the power cutter? 4

GENERAL SAFETY PRECAUTIONS

Steps before using a new power cutter 5

Personal protective equipment 5

SAFETY INSTRUCTIONS

General safety warnings 6

Machine's safety equipment 7

Diamond blades 8

General working instructions 9

ASSEMBLY

Assembly 12

STARTING AND STOPPING

Before starting 13

Starting 13

Stopping 13

MAINTENANCE

General 14

Cleaning 14

Inspecting and adjusting the drive belt 14

Replacing the drive belt 15

Cooling system 16

Replacing the carbon brushes 16

Water tap 16

Electrical Feed 16

Daily maintenance 16

TECHNICAL DATA

Cutting equipment 17

Recommended cable dimensions 17

EC-declaration of conformity 18

WHAT IS WHAT?

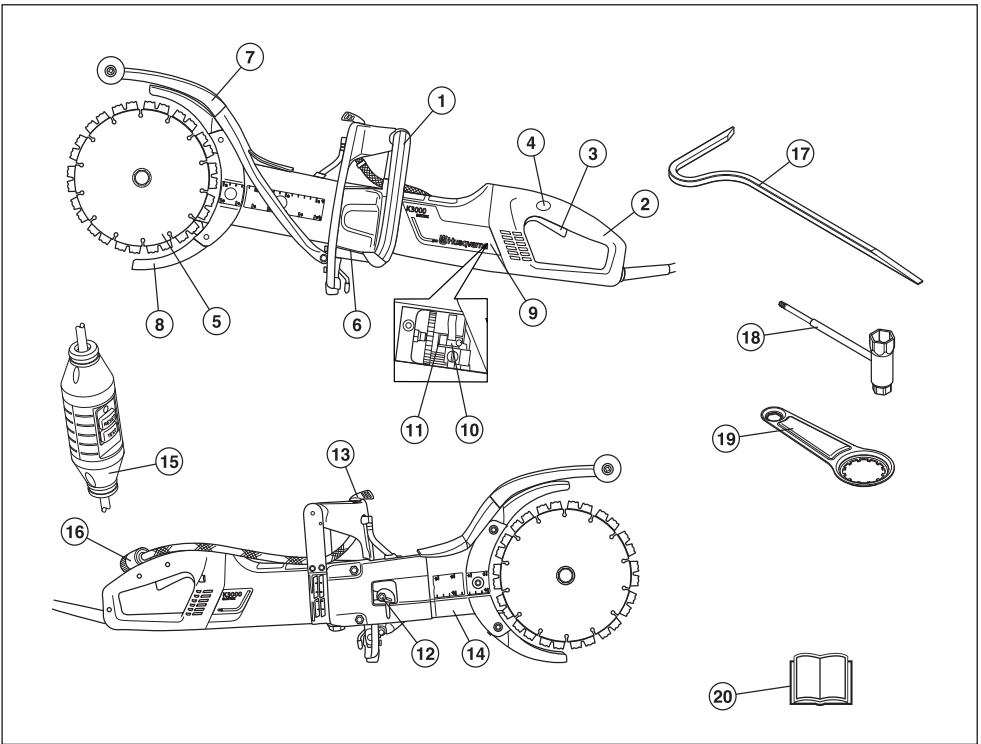

What is what on the power cutter?

- | | |
|---------------------|--|
| 1 Front handle | 11 Brush retainer |
| 2 Rear handle | 12 Belt tensioner |
| 3 Switch | 13 Water tap |
| 4 Power switch lock | 14 Cutting arm |
| 5 Blades | 15 Ground fault circuit interrupter (not for GB) |
| 6 Rating plate | 16 Water connector |
| 7 Splash guard | 17 Breaking tool |
| 8 Blade guards | 18 Combination spanner |
| 9 Inspection covers | 19 Bearing tool |
| 10 Carbon brushes | 20 Operator's manual |

GENERAL SAFETY PRECAUTIONS

Steps before using a new power cutter

- Please read the operator's manual carefully and make sure you understand the instructions before using the machine.
- The machine is only designed for cutting hard materials, such as concrete, brick, masonry as well as cast iron and cement pipes.
- Let your Husqvarna dealer regularly check the power cutter and make essential adjustments and repairs.



WARNING! Under no circumstances should you modify the original design of the machine without approval from the manufacturer. Always use original spare parts. Unauthorized modifications and/or accessories may lead to serious injury or death to the user or others.



WARNING! Use of products which cut, grind, drill, sand or shape material can generate dust and vapors which may contain harmful chemicals. Know the nature of the material being worked on and wear appropriate dust mask or respirator protection.



WARNING! A power cutter is a dangerous tool if used carelessly or incorrectly and can cause serious, even fatal injuries. It is extremely important that you read and understand the contents of this Operator's Manual.

Husqvarna Construction Products has a policy of continuous product development. Husqvarna reserves the right to modify the design and appearance of products without prior notice and without further obligation introduce design modifications.

All information and all data in the Operator's Manual were applicable at the time the Operator's Manual was sent to print.

Personal protective equipment



WARNING! You must use approved personal protective equipment whenever you use the machine. Personal protective equipment cannot eliminate the risk of injury but it will reduce the degree of injury if an accident does happen. Ask your dealer for help in choosing the right equipment.

- Protective helmet
- Hearing protection
- Protective goggles or a visor



- Breathing mask



- Heavy-duty, firm grip gloves.



- Tight-fitting, heavy-duty and comfortable clothing that permits full freedom of movement.



- Use leg-guards recommended for the material to be cut.
- Boots with steel toe-caps and non-slip sole.



- Always have a first aid kit nearby.



SAFETY INSTRUCTIONS

General safety warnings



WARNING! Read all safety warnings and all instructions. Failure to follow the warnings and instructions may result in electric shock, fire and/or serious injury.

Save all warnings and instructions for future reference.

The term "power tool" in the warnings refers to your mains-operated (corded) power tool or battery-operated (cordless) power tool.

Work area safety

- Keep work area clean and well lit. Cluttered or dark areas invite accidents.
- Do not operate power tools in explosive atmospheres, such as in the presence of flammable liquids, gases or dust. Power tools create sparks which may ignite the dust or fumes.
- Keep children and bystanders away while operating a power tool. Distractions can cause you to lose control.
- Do not use the machine in bad weather, such as dense fog, rain, strong wind, intense cold, etc. Working in bad weather is tiring and can lead to dangerous conditions, e.g. slippery surfaces.
- Ensure when cutting that no material can become loose and fall, causing operating injury. Take great care when working on sloping ground.



WARNING! The safety distance for the power cutter is 15 metres. You are responsible to ensure that animals and onlookers are not within the working area. Do not start cutting until the working area is clear and you are standing firmly.

Electrical safety

- Power tool plugs must match the outlet. Never modify the plug in any way. Do not use any adapter plugs with earthed (grounded) power tools. Unmodified plugs and matching outlets will reduce the risk of electric shock.
- Avoid body contact with earthed or grounded surfaces, such as pipes, radiators, ranges and refrigerators. There is an increased risk of electric shock if your body is earthed or grounded.
- The power tool should not be exposed to more moisture than what is supplied by the low flushing water system. Do not expose the power tool to rain. Water entering a power tool will increase the risk of electric shock.
- Do not abuse the cord. Never use the cord for carrying, pulling or unplugging the power tool. Keep cord away from heat, oil, sharp edges or moving parts. Damaged or entangled cords increase the risk of electric shock.

- When operating a power tool outdoors, use an extension cord suitable for outdoor use. Use of cord suitable for outdoor use reduces the risk of electric shock.
- Check that the cord and extension cord are intact and in good condition. Never use the machine if the cord is damaged, hand it in to an authorized service workshop for repair.
- Do not use an extension cord while it is rolled up to avoid overheating.
- When using an extension cable, use only certified extension cables with sufficient reach. For more information, see "Recommended cable dimensions" in the "Technical data" section. An undersized cable means a risk of reduced machine capacity and overheating.
- The machine should be connected to an earthed outlet socket. Check that the mains voltage corresponds with that stated on the rating plate on the machine.
- Ensure the cord is behind you when you start to use the machine so that the cord will not be damaged.



WARNING! The machine (Great Britain 110V) is not equipped with a ground fault circuit interrupter. The machine must always be used with an isolating transformer for protection in case an electrical fault should occur.

Personal safety

- Stay alert, watch what you are doing and use common sense when operating a power tool. Do not use a power tool while you are tired or under the influence of drugs, alcohol or medication. A moment of inattention while operating power tools may result in serious personal injury.
- Use personal protective equipment. Always wear eye protection. Protective equipment such as dust mask, non-skid safety shoes, hard hat, or hearing protection used for appropriate conditions will reduce personal injuries.
- Prevent unintentional starting. Ensure the switch is in the OFF-position before connecting to power source and/or battery pack, picking up or carrying the tool. Carrying power tools with your finger on the switch or energising power tools that have the switch on invites accidents.
- Remove any adjusting key or wrench before turning the power tool on. A wrench or a key left attached to a rotating part of the power tool may result in personal injury.
- Do not overreach. Keep proper footing and balance at all times. This enables better control of the power tool in unexpected situations.
- Dress properly. Do not wear loose clothing or jewellery. Keep your hair, clothing and gloves away from moving parts. Loose clothes, jewellery or long hair can be caught in moving parts.

SAFETY INSTRUCTIONS

- If devices are provided for the connection of dust extraction and collection facilities, ensure that these are connected and properly used. Use of dust collection can reduce dust-related hazards.
- Remain at a distance from the blades when the engine is running.



WARNING! Overexposure to vibration can lead to circulatory damage or nerve damage in people who have impaired circulation. Contact your doctor if you experience symptoms of overexposure to vibration. These symptoms include numbness, loss of feeling, tingling, pricking, pain, loss of strength, changes in skin colour or condition. These symptoms normally appear in the fingers, hands or wrists.

Power tool use and care

- Do not force the power tool. Use the correct power tool for your application. The correct power tool will do the job better and safer at the rate for which it was designed.
- Do not use the power tool if the switch does not turn it on and off. Any power tool that cannot be controlled with the switch is dangerous and must be repaired.
- Disconnect the plug from the power source and/or the battery pack from the power tool before making any adjustments, changing accessories, or storing power tools. Such preventive safety measures reduce the risk of starting the power tool accidentally.
- Store idle power tools out of the reach of children and do not allow persons unfamiliar with the power tool or these instructions to operate the power tool. Power tools are dangerous in the hands of untrained users.
- Maintain power tools. Check for misalignment or binding of moving parts, breakage of parts and any other condition that may affect the power tool's operation. If damaged, have the power tool repaired before use. Many accidents are caused by poorly maintained power tools.
- Keep cutting tools sharp and clean. Properly maintained cutting tools with sharp cutting edges are less likely to bind and are easier to control.
- Use the power tool, accessories and tool bits etc. in accordance with these instructions, taking into account the working conditions and the work to be performed. Use of the power tool for operations different from those intended could result in hazardous situations.
- Never use a machine that has been modified in any way from its original specification.
- Make sure that no pipes or electrical cables are routed in the working area or in the material to be cut.

- Always check and mark out where gas pipes are routed. Cutting close to gas pipes always entails danger. Make sure that sparks are not caused when cutting in view of the risk of explosion. Remain concentrated and focused on the task. Carelessness can result in serious personal injury or death.
- Inspect new blades for transport or storage damage.
- The guard for the cutting equipment must always be on when the machine is running.

Service

- Have your power tool serviced by a qualified repair person using only identical replacement parts. This will ensure that the safety of the power tool is maintained.

Machine's safety equipment

This section describes the machine's safety equipment, its purpose, and how checks and maintenance should be carried out to ensure that it operates correctly. See the "What is what?" section to locate where this equipment is positioned on your machine.



WARNING! Never use a machine that has faulty safety equipment! Carry out the inspection, maintenance and service routines listed in this section.

All servicing and repair work on the machine requires special training. This is especially true of the machine's safety equipment. If your machine fails any of the checks described below you must contact your service agent. When you buy any of our products we guarantee the availability of professional repairs and service. If the retailer who sells your machine is not a servicing dealer, ask him for the address of your nearest service agent.

Switch

The power switch should be used to start and stop the machine.

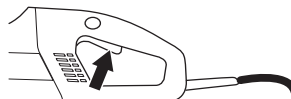

Checking the power switch

- Start the machine, release the power switch and check that the engine and the cutting blade stop.

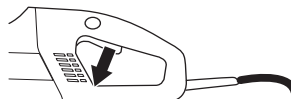

- A defective power switch should be replaced by an authorized service workshop.

SAFETY INSTRUCTIONS

Power switch lock

The power switch lock is designed to prevent accidental operation of the switch. When the lock (A) is pressed in the power switch (B) is released.

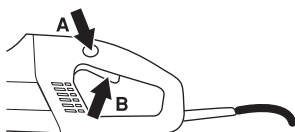

The power switch lock remains depressed as long as the power switch is depressed. When the lock (A) is pressed in the power switch (B) is released. This movement is controlled by two independent return springs. This position results in the machine stopping and the power switch being locked.

Checking the power switch lock

- Make sure the power switch is locked when the power switch lock is in its original position.

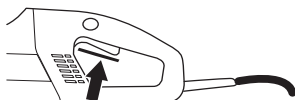

- Press in the power switch lock and make sure it returns to its original position when you release it.

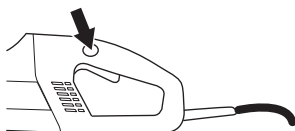

- Check that the power switch and power switch lock move freely and that the return springs work properly.

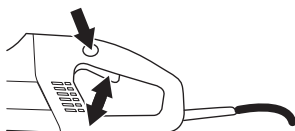

- Switch on the machine, release the switch, and check that the engine and blades stop.

Gradual start and overload protection

The machine is equipped with electronically controlled gradual start and overload protection.

The engine starts to pulsate if the machine is loaded above a specific level. If the load is reduced the engine reverts to its normal state and cutting can resume.

The electronics will cut the current after a set time if the machine continues to be run with a pulsating engine. The higher load the faster the shutoff.

The electronics cut the current immediately if the blade jams.

Blade guards

This guard is fitted above and below the cutting blade and is designed to prevent parts of the blade or cutting fragments from being thrown towards the user.

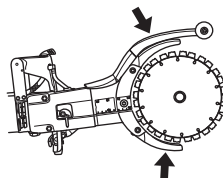

Checking the blade guards



WARNING! Always check that the guard is correctly fitted before starting the machine. Check that the cutting blade is fitted correctly and does not show signs of damage. A damaged cutting blade can cause personal injury. See instructions under the heading Assembly.

- Check that the guard is complete and without any cracks or deformations.
- Never use a defective guard or a guard that has not been fitted correctly.

Diamond blades



WARNING! Blades can break and cause serious injuries to the user.

Never use blades other than original blades designed for the machine.

Never use blades on a material other than the one they are intended for.



WARNING! Cutting plastics with diamond blades can cause kickback when the material melts, due to the heat produced when cutting, and sticks to the blades. Avoid cutting plastics.

General

- Only use special diamond blades with integrated belt pulley halves on this machine.
- Diamond blades consist of a steel core provided with segments that contain industrial diamonds.

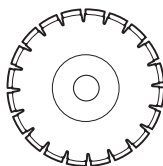

SAFETY INSTRUCTIONS

- Always use a sharp diamond blade.
- Ensure the blades are not cracked or damaged in any other way. Replace blades if necessary.

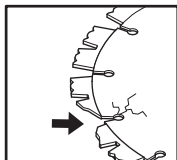

Water cooling

- Water cooling must always be used. This cools the blades and increases their life and prevents dust build-up.



WARNING! Cool diamond blades designed for wet cutting continuously with water to prevent heating, which can deform the diamond blade resulting in damage to the machine and personal injury.

Blade vibrations

- The blades can become out of true and vibrate if a too high feed pressure is used.
- A lower feed pressure can stop the vibration. Otherwise replace the blades. See the instructions under the heading Assembling the blades.
- The blades shall be intended for the material to be cut.

Material

- Diamond blades are ideal for masonry, reinforced concrete and other composite materials.
- Diamond blades are available in several hardness classes. The blades shall be intended for the material to be cut. A "soft" diamond blade has a relatively short service life and large cutting capacity. It is used for hard materials such as granite and hard concrete. A "hard" diamond blade has a longer service life and reduced cutting capacity, and should be used for soft materials such as brick and asphalt.

Sharpening diamond blades

- Diamond blades can become dull when the wrong feeding pressure is used or when cutting certain materials such as heavily reinforced concrete. Working with a blunt diamond blade causes overheating, which can result in the diamond segments coming loose.
- Sharpen the blade by cutting in a soft material such as sandstone or brick.

High speed handheld machines

- Only use special blades with integrated belt pulley halves on this machine.
- The blades should be marked with the same or a higher speed than that stated on the machine's rating plate. Never use blades at a lower speed rating than that of the power cutter.

General working instructions



WARNING! This section describes basic safety directions for using a power cutter. This information is never a substitute for professional skills and experience. If you get into a situation where you feel unsafe, stop and seek expert advice. Contact your dealer, service agent or an experienced power cutter user. Do not attempt any task that you feel unsure of!

Water cooling

Water cooling must always be used.



At a low water pressure, for example when the water tank is used, the restrictor can be dismantled to give the correct water flow.

NOTE!

It is important not to use a too high water flow without throttling as the belt can then slip.

Cutting technique

- Support the work piece in such a way that it is possible to predict what will happen, and so that the cut remains open while cutting.

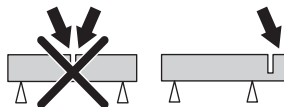

- Always hold the machine in a firm grip with both hands. Hold it so that the thumbs and fingers grip round the handles.

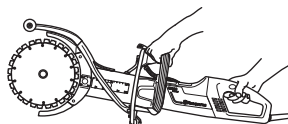

SAFETY INSTRUCTIONS

- Check that the blade is not in contact with anything when the machine is started
- Start cutting with the machine running at maximum speed.
- Start cutting smoothly, allowing the machine to work without forcing or pressing in the blade. Always cut at maximum speed.
- Cut in the same direction when cutting into an existing cut. Avoid cutting at an angle to the previous cut otherwise there is a risk of the blade jamming or that the machine can "climb in the cut".

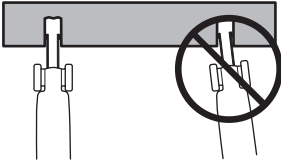

- Always cut from top to bottom (A).
- Remove the cutter and use a crowbar to remove the material that remains between the cut (B).

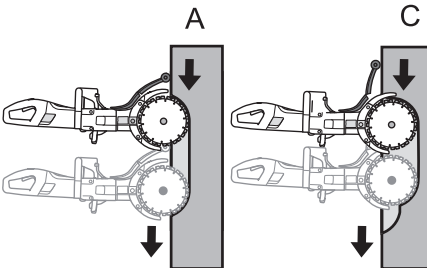

- Follow the same saw cut, but further in the work piece (C), and repeat the work with the crowbar.

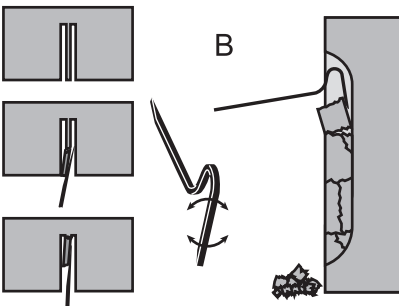

WARNING! When cutting vertically, always cut from the top of the cut and down. Never cut from the bottom of the cut and up. This can cause a kickback and result in personal injury.

- Repeat this working method until the required cutting depth is achieved (D, E).

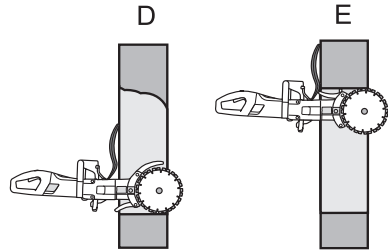

- The blade guards are designed to easily adapt to how deep in the work piece the power cutter is moved.

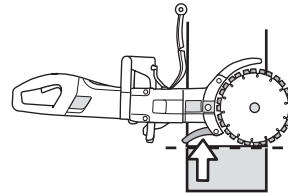

WARNING! Under all circumstances avoid grinding using the side of the blade; it will almost certainly be damaged, break and can cause immense damage. Only use the cutting section.

Do not pull the power cutter to one side, this can cause the blade to jam or break resulting in injury to people.

Smooth cutting

To enable smooth cutting, the splash guard must be adjusted.

- Release the latch.

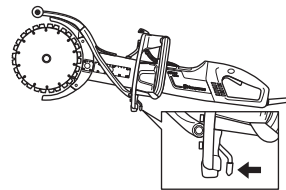

- Slide the splash guard sideways.

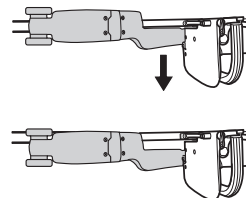

- Lock the latch.

SAFETY INSTRUCTIONS

Kickback

Kickback is a sudden, rearward motion of the saw that can occur if the blades are stalled (pinched, jammed, twisted) in the so called kickback zone. Most kickbacks are small and felt as small "jerks" in the front handle. However, kickback can be very powerful. If you are not paying attention or have a poor grip the saw can be thrown all the way back at you.



WARNING! Kickback can be very sudden and violent, throwing the saw back at you. It can cause serious or even fatal injuries. It is vital you understand what causes kickback and how to avoid it using proper cutting technique.

Cause of kickback

Kickback is caused if you are cutting with the kickback zone of the blade for example when cutting "upwards" or towards you.

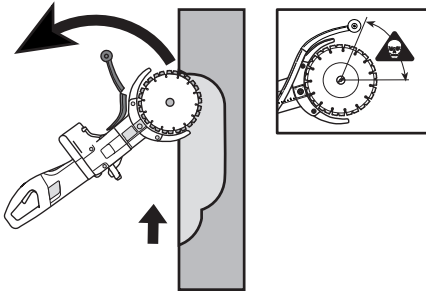

General rules

- Never cut upwards or towards you so that the kickback zone becomes actively cutting.

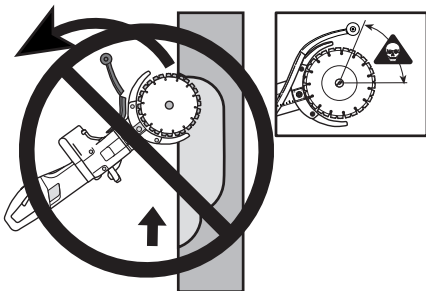

- Always hold the machine in a firm grip with both hands. Hold it so that the thumbs and fingers grip round the handles.

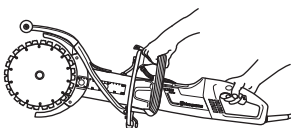

- Keep a good balance and a firm foothold.
- When cutting vertically, always cut from the top of the cut and down.
- Always cut at maximum speed.
- Do not cut with the upper quadrant (kickback zone) of the blade. Avoid twisting or pushing the blades sideways in the cut. This can cause kickback.
- Take care when inserting the blade in an existing cut. Make certain that the cut is wide enough and that the blades are not angled in the cut. This can cause kickback.
- Stand at a comfortable distance from the work piece.
- Never cut above shoulder height.
- Never cut from a ladder. Use a platform or scaffold when working at high altitude.
- Be alert to movement of the work piece or anything else that can occur, which could cause the cut to close and pinch the blade.

Pull in

Pull in occurs when the blades' lower sections suddenly stop or when the cut closes. (To avoid, see the instructions under the heading "Basic rules" and "Jamming/rotation", here below.)

Pinching/rotation

If the cut is pressed together this can lead to jamming. The machine can be pulled down suddenly with a very powerful jerk.

How to avoid pinching

Support the work piece in such a way that the cut remains open during the cutting operation and when the cut is finished.

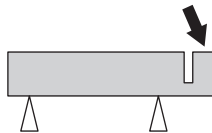

Check the engine speed

Use a revolution counter regularly to check the engine speed at the working temperature, at full throttle and without a load.

ASSEMBLY

Assembly



WARNING! Always pull out the plug from the outlet socket before cleaning, maintenance or assembly.

Assembling the blades

- Husqvarna blades are especially manufactured and approved for freehand cutting with the K3000 Cut-n-Break. The blades have integrated belt pulley halves and are to be changed in pairs.
- Loosen the nuts and clamping bolt which release the bar. This will position the drive belt in a more favourable position with regard to assembling the new blades. **The drive belt is not clamped so easily.**

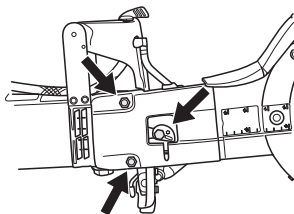

- Dismantle the old blades by loosening the centre nut. Check the drive belt for wear when the blades are dismantled. When changing the drive belt see the instructions under the heading "Replacing the drive belt".
- Position the blades on each side of the cutting arm. Make sure that the holes for both guide pins in the drive belt halves are aligned so that they correspond with the holes in the washer, and the nut too. Now fit the bolt and washer unit with guide pins.

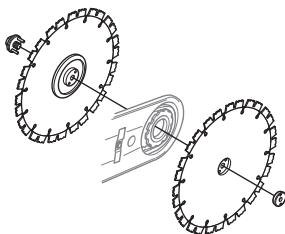

NOTE!

It is very important that the blades rotate when the nut is tightened. This is to ensure that the belt is not clamped between the integrated drive belt halves on the blades when the blades/drive belt are pulled together with the nut. Ideally this is done alternately, i.e. tighten a little, rotate a little and repeat until the blades are secured.

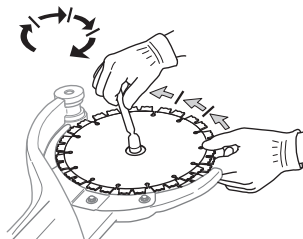

IMPORTANT! Do not forget to tighten the belt and check the belt adjustment before cutting. See the instructions under the heading "Inspecting and adjusting the drive belt".

Protection for the blades

- The guards should always be fitted on the machine. Check that the guards are properly secured and work before starting to cut.

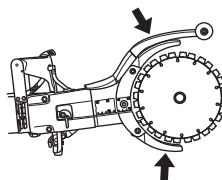

STARTING AND STOPPING

Before starting



WARNING! Note the following before starting:

The machine should be connected to an earthed outlet socket.

Check that the mains voltage corresponds with that stated on the rating plate on the machine.

Make sure you have a secure footing and that the cutting blade cannot touch anything.

Keep people and animals well away from the working area.



WARNING! The machine (Great Britain 110V) is not equipped with a ground fault circuit interrupter. The machine must always be used with an isolating transformer for protection in case an electrical fault should occur.

Water connector

- Connect the water hose to the water supply (A). The water flow is regulated using the water tap (B).

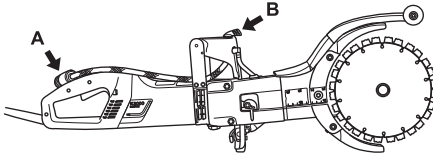

Starting

- Grip the front handle with the left hand.
- Grip the rear handle with your right hand.

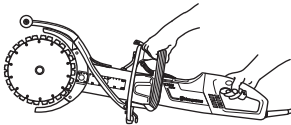

- Press in the power switch lock with your right-hand thumb and press in the power switch.

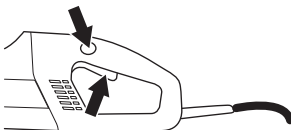

- Run the machine unloaded and in a safe manner for at least 30 seconds.

Stopping

- Stop the motor by releasing the power switch.

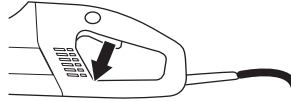

WARNING! The cutting blade continues to rotate for some time after the motor has stopped.

MAINTENANCE

General



WARNING! Inspection and/or maintenance should be carried out with the motor switched off and the plug disconnected.

Cleaning



WARNING! Do not use a high pressure washer when rinsing the inside of the machine.

The machine can withstand taking in damp air and splashes during the cutting process. Clean water does not affect the machine's function.

When cutting materials such as concrete or brick, which can contain salt, you must rinse the machine after the work is finished. The cleaning reduces the risk for accretions building up inside the engine, which can cause leakage current between electric components, which in turn can cause the ground fault circuit interrupter to turn off without intention.

- Clean the machine daily by rinsing it with clean water after the work is finished.
- Place the machine with the rear handle facing upwards. Rinse the air intakes at the rear handle with clean water. The water will run out through the front air outlets.
- Connect the plug and run the engine dry for approx. 30 sec in order to speed up the drying of the engine.

Inspecting and adjusting the drive belt



- The drive belt is fully enclosed and well-protected from dust, dirt and mechanical damage when cutting.

Check the tension of the drive belt

- Stick a screwdriver in the notch.
- A correctly adjusted drive belt should have about 5 mm of movement.

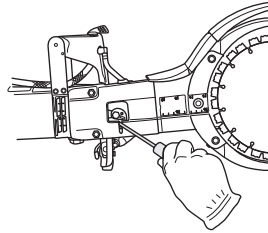

Tighten the drive belt

- Loosen the two nuts.
- Loosen the clamping bolt.

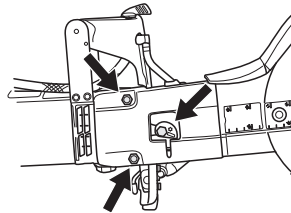

- Turn the eccentric plate anti-clockwise with a screwdriver or a torx driver. This tightens the drive belt by pushing the bar forwards.

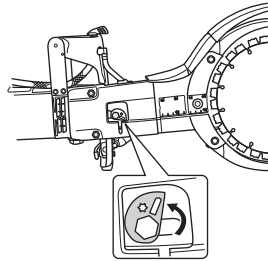

- Tighten the nuts.
- Screw the bolt tight. Hold still the eccentric plate so that it doesn't move along when you tighten the screws.

IMPORTANT! A new drive belt shall be tightened once after 30-60 minutes operation.

MAINTENANCE

Replacing the drive belt

- Release the belt tension.
- Remove the blades.

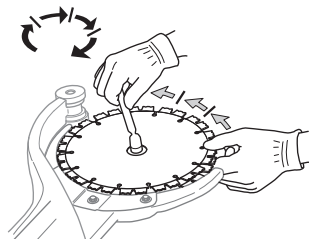

- Remove the belt cover by loosening the nuts, the clamping bolt and the eccentric cam.

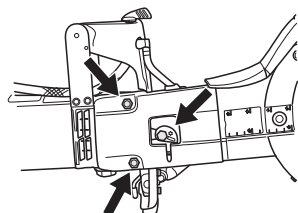

- Loosen water hose.

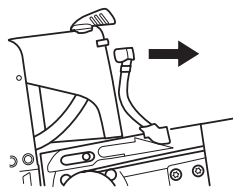

- Loosen the drive gear. Use a spanner as a counterhold. (The combination spanner or bearing tool can be used as a counterhold.)

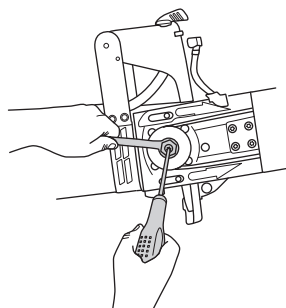

- Remove the cutting arm by pulling it straight out from the machine.

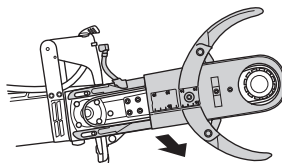

- Loosen the five screws holding the guards on the cutting arm.

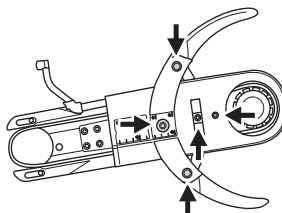

- Remove the old drive belt and put in a new one.
- Refit the guards on the cutting arm.
- Fit the cutting arm on the machine while fastening the drive wheel.
- Replace the water hose.
- Refit the belt cover, the nuts, the clamping bolt and the eccentric cam.
- Refit the blades and tighten the nut. See instructions under Heading "Assembling the blades".
- Tighten the drive belt and the nuts and bolt. See the instructions under the heading "Inspecting and adjusting the drive belt".

IMPORTANT! Do not forget to tighten the belt and check the belt adjustment before cutting. See the instructions under the heading "Inspecting and adjusting the drive belt".

MAINTENANCE

Cooling system



- The machine is equipped with an efficient fan to cool the motor. Cooling air which is drawn in through the grille by the machines rear handle passes over the stator and rotor and out through the front of the motor housing.

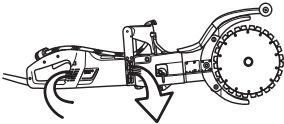

- In order for the machine to always be cooled sufficiently the cooling air openings must be kept clear and clean. Blow down the machine regularly with compressed air.

Replacing the carbon brushes

- Check the carbon brushes at least once a month. The carbon brushes should be replaced with new brushes if they are worn, cracked or in any other way deformed.
- All carbon brushes must be replaced when the brushes are replaced.
- Remove both inspection covers by loosening both screws.

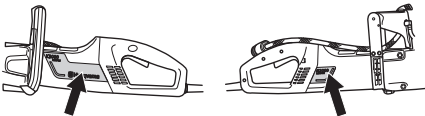

- Unscrew the cable holding the carbon brush. Now lift up the spring and then lift out the carbon brush from the brush retainer.

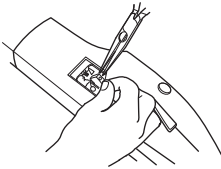

- Clean the brush retainers with a dry brush.
- Carefully blow away the dust.
- Fit the new carbon brushes and, at the same time, check that they slide easily in the brush retainers.
- Fold down the springs and tighten the cable.
- New carbon brushes must be run in for approximately 40 minutes while idling.

Water tap

- Check and clean the restrictor if necessary. Do not use hoses that are distorted, worn or damaged.

Electrical Feed



WARNING! Never use damaged cables. They can cause serious, even fatal, personal injuries.

- Check that the cord and extension cord are intact and in good condition. Never use the machine if the cord is damaged, hand it in to an authorized service workshop for repair.

Daily maintenance

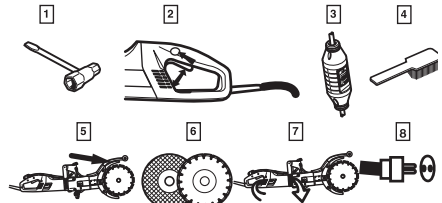

- 1 Check that nuts and screws are tight.
- 2 Check that the power switch unit works smoothly.
- 3 Check the ground fault circuit interrupter
- 4 Clean the outside of the machine.
- 5 Checking the blade guard
- 6 Check the condition of the cutting blade.
- 7 Check and clean the cooling air openings.
- 8 Check that the cord and extension cord are intact and in good condition.

TECHNICAL DATA

Technical data		K 3000 Cut-n-Break
Engine		
Protection class		I
Max. blade speed, rpm	230V, 50Hz	4250
	120V, 60Hz	4460
Rated voltage, V		
Europe		230
Great Britain		110
USA / Canada / Japan		100-120
Rated output, W		
Europe		230V, 50Hz 2700/12 A
Great Britain		110V, 50Hz 2200/20 A
USA / Canada / Japan		100-120V, 50-60Hz 15 A
Weight		
Power cutter without blades, kg		7,9
Water cooling		
Water cooling		Yes
Water connector		Type "Gardena"
Water pressure - max, bar		8

Noise emissions (see note 1)	
Sound power level, measured dB (A)	108
Sound power level, guaranteed dB(A)	109
Sound levels (see note 2)	
Sound pressure level at the operators ear, dB(A)	95
Vibration levels (see note 3)	
Front handle, m/s ²	3,2
Rear handle, m/s ²	3,4

Note 1: Noise emissions in the environment measured as sound power (L_{WA}) in conformity with EN 60745-2-3.

Note 2: Noise pressure level according to EN 60745-2-3. Reported data for noise pressure level has a typical statistical dispersion (standard deviation) of 1.0 dB(A).

Note 3: Vibration level according to EN EN 60745-2-3. Reported data for vibration level has a typical statistical dispersion (standard deviation) of 1 m/s².

Cutting equipment

Cutting blade, mm/inches	Gear ratio	Max. peripheral speed, m/s	Cutting depth, mm/inches
225/9	45/79	60	400/16

Recommended cable dimensions

Cable area	1,5 mm ²	2,5 mm ²
Input voltage 100-120 V	20 m	40 m
Input voltage 220-240 V	30 m	50 m

TECHNICAL DATA

EC Declaration of Conformity

(Applies to Europe only)

Husqvarna AB, SE-433 81 Göteborg, Sweden, tel: +46-31-949000, declares under sole responsibility that the power cutter **Husqvarna 3000 Cut-n-Break** dating from 2010 serial numbers and onwards (the year is clearly stated on the rating plate, followed by the serial number), complies with the requirements of the COUNCIL'S DIRECTIVE:

- of May 17, 2006 "relating to machinery" **2006/42/EC**.
- of December 15, 2004 "relating to electromagnetic compatibility" **2004/108/EC**.
- of December 12, 2006 "relating to electrical equipment" **2006/95/EC**.
- of June 08, 2011 on the 'restriction of use of certain hazardous substances' **2011/65/EU**

The following standards have been applied: EN ISO 12100:2010, EN 55014-1:2006, EN 55014-2/A1:2001, EN 61000-3-2:2006, EN 61000-3-3/A1/A2:2005, EN 60745-1:2009, IEC 60745-2-22:2009.

Gothenburg 5 January 2015



Helena Grubb

Vice President, Construction Equipment Husqvarna AB

(Authorized representative for Husqvarna AB and responsible for technical documentation.)

1153344-26
Original instructions



2015-01-30 rev. 2